

Features

- GAIN BANDWIDTH:15kHz
- RAIL-TO-RAIL INPUT AND OUTPUT
0.5mV Typical V_{os}
- INPUT VOLTAGE RANGE: -0.1V to +5.6V
with $V_s = 5.5V$
- SUPPLY RANGE: +1.4V to +5.5V
- SPECIFIED UP TO +125°C
- Micro SIZE PACKAGES: SOT23-5

Application

- SENSORS
- PHOTODIODE AMPLIFICATION
- WEARABLE PRODUCTS
- TEMPERATURE MEASUREMENT
- BATTERY POWERED SYSTEM

Description

The CBM8031, CBM8032, CBM8034, families of products offer low voltage operation and rail-to-rail input and output, as well as excellent speed/power consumption ratio, providing an excellent bandwidth (15kHz) and slew rate of 7.5V/ms. The op-amps are unity gain stable and feature an ultra-low input bias current.

The devices are ideal for sensor interfaces, active filters and portable applications. The CBM8031, CBM8032, CBM8034 families of operational amplifiers are specified at the full temperature range of -40°C to +125°C under single or dual power supplies of 1.4V to 5.5V.

PIN CONFIGURATIONS

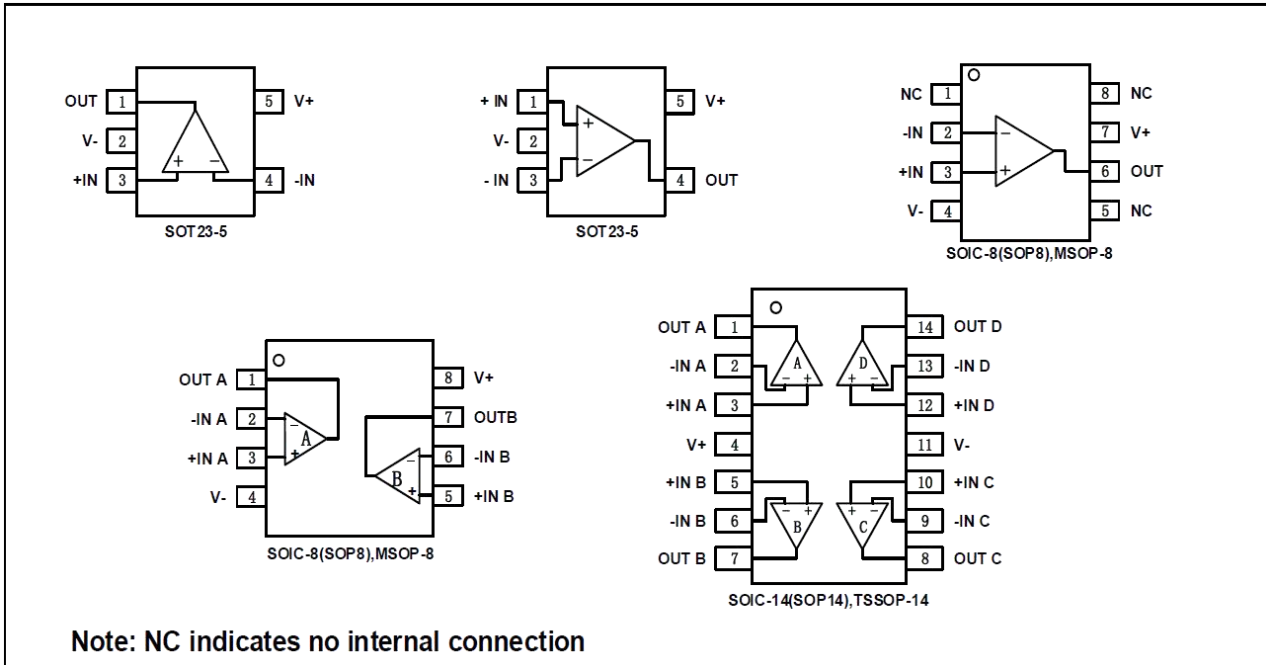

ABSOLUTE MAXIMUM RATINGS ⁽¹⁾

Supply Voltage, V+ to V-.....	7.0V
Input Terminals, Voltage ⁽²⁾	- 0.5 to (V+) + 0.5V
Current ⁽²⁾	±10mA
Storage Temperature	-65°C to +150°C
Operating Temperature	-40°C to +125°C
Junction Temperature.....	150°C
Package Thermal Resistance @ T _A = +25°C	
SOT23-5, SOT23-6.....	200°C/W
MSOP-10, SOIC-8	150°C/W
SOIC-14, TSSOP-14.....	100°C/W
Lead Temperature (Soldering, 10s)	260°C
ESD Susceptibility	
HBM	5000V
MM	400V

(1) Stresses above these ratings may cause permanent damage. Exposure to absolute maximum conditions for extended periods may degrade device reliability. These are stress ratings only, and functional operation of the device at these or any other conditions beyond those specified is not implied.

(2) Input terminals are diode-clamped to the power-supply rails. Input signals that can swing more than 0.5V beyond the supply rails should be current-limited to 10mA or less.



ESD SENSITIVITY CAUTION

ESD damage can range from subtle performance degradation to complete device failure. Precision integrated circuits may be more susceptible to damage because very small parametric changes could cause the device not to meet its published specifications.

ELECTRICAL CHARACTERISTICS

(At $T_A = +25^\circ\text{C}$, $V_S = 5.0\text{V}$, $R_L = 1\text{M}\Omega$ connected to $V_S/2$, and $V_{OUT} = V_S/2$, unless otherwise noted.)

PARAMETER	CONDITIONS	CBM8031, CBM8032, CBM8034			UNIT	
		MIN	TYP	MAX		
POWER SUPPLY						
V_S	Operating Voltage Range		1.4		5.5	V
I_Q	Quiescent Current/Amplifier			670	1500	nA
PSRR	Power-Supply Rejection Ratio	$V_S = 2.5\text{V to } 5.5\text{V}$, $V_{cm} = (V_-) + 0.5\text{V}$	62	70		dB
INPUT						
V_{os}	Input Offset Voltage	$V_{cm} = V_S/2$		0.5	3	mV
$\Delta V_{os}/\Delta T$	Input Offset Voltage Drift	$V_{cm} = V_S/2$, -40°C $\leq T_A \leq 125^\circ\text{C}$		2.3		$\mu\text{V}/^\circ\text{C}$
I_B	Input Bias Current			1	10	pA
I_{os}	Input Offset Current			1	10	pA
V_{cm}	Common-Mode Voltage Range	$V_S = 5.5\text{V}$	-0.1		5.6	V
CMRR	Common-Mode Rejection Ratio	$V_S = 5.5\text{V}$, $V_{cm} = -0.1\text{V to } 4\text{V}$	73	90		dB
		$V_S = 5.5\text{V}$, $V_{cm} = -0.1\text{V to } 5.6\text{V}$	60	83		
OUTPUT						
AOL	Open-Loop Voltage Gain	$V_S = 1.4\text{V}$, $R_L = 50\text{k}\Omega$, $V_o = V_S - 0.1\text{V}$	85	102		dB
		$V_S = 5.0\text{V}$, $R_L = 50\text{k}\Omega$, $V_o = V_S - 0.1\text{V}$	92	106		
	Output Swing From Rail	$R_L = 50\text{k}\Omega$		5		mV
I_{out}	Output Short-Circuit Current			11		mA

FREQUENCY RESPONSE						
SR	Slew Rate			7.5		V/us
GBP	Gain-Bandwidth Product			15		MHz
PM	Phase Margin			60		°
NOISE						
e_{np-p}	Input Voltage Noise Density	f = 0.1 Hz to 10 Hz		2.4		μV_{pp}
e_n	Input Voltage Noise Density	f = 1 kHz		160		nV/ \sqrt{Hz}

TYPICAL CHARACTERISTICS

At $T_A = +25^\circ\text{C}$, $V_S = 5\text{V}$, $R_L = 1\text{M}\Omega$ connected to $V_S/2$, $C_L = 60\text{pF}$, $V_{CM} = V_S/2$, unless otherwise noted.

SMALL-SIGNAL STEP RESPONSE

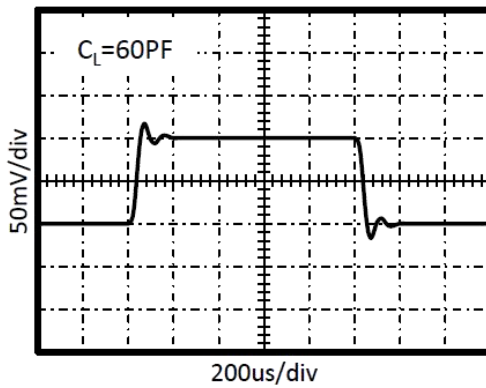

SMALL-SIGNAL STEP RESPONSE

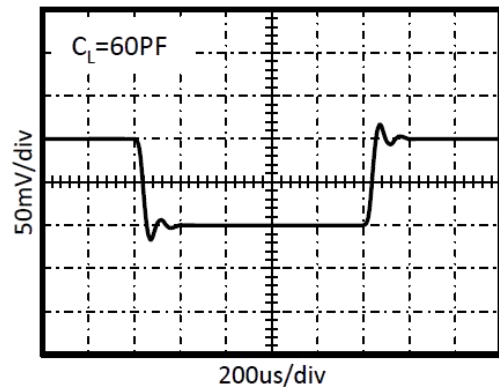

LARGE-SIGNAL STEP RESPONSE

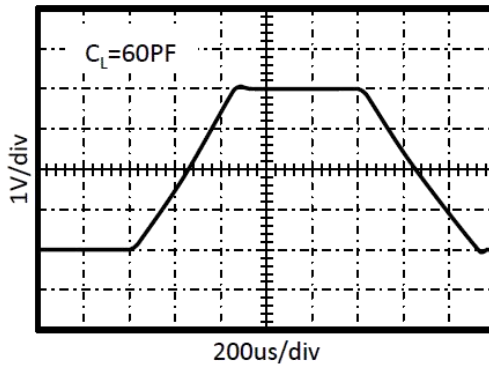

LARGE-SIGNAL STEP RESPONSE

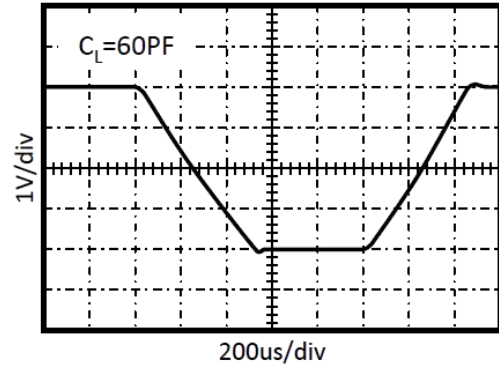

SINK CURRENT vs TEMPERATURE

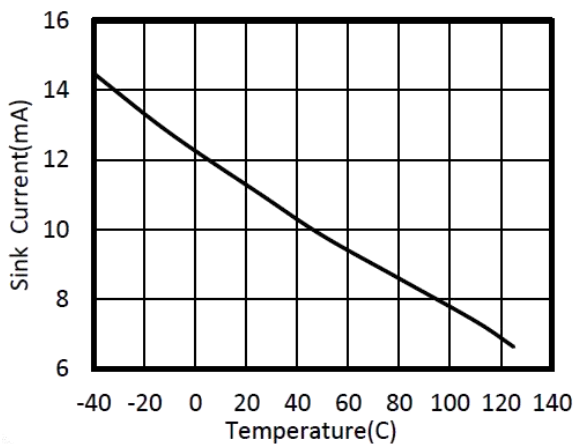

SOURCE CURRENT vs TEMPERATURE

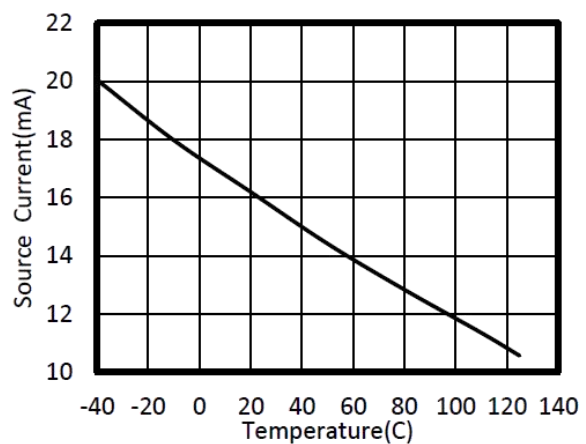

PACKAGE OUTLINE DIMENSIONS

SOT23-5

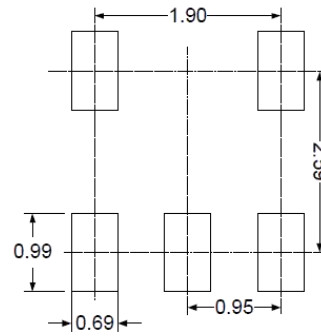
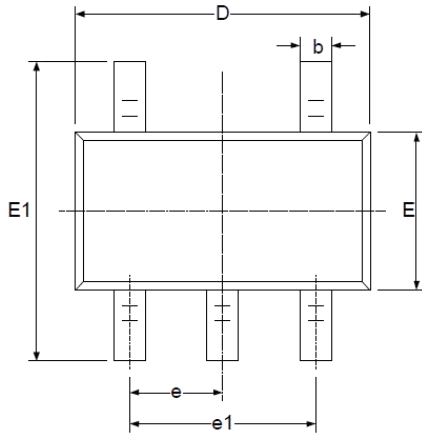

RECOMMENDED LAND PATTERN (Unit: mm)

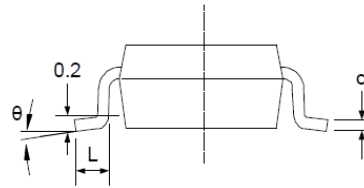
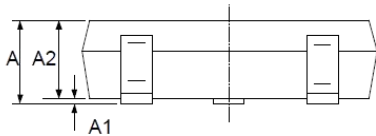

Symbol	Dimensions In Millimeters		Dimensions Inches	
	Min	Max	Min	Max
A	1.050	1.250	0.041	0.049
A1	0.000	0.100	0.000	0.004
A2	1.050	1.150	0.041	0.045
b	0.300	0.500	0.012	0.020
c	0.100	0.200	0.004	0.008
D	2.820	3.020	0.111	0.119
E	1.500	1.700	0.059	0.067
E1	2.650	2.950	0.104	0.116
e	0.950 BSC		0.037 BSC	
e1	1.800	2.000	0.071	0.079
L	0.300	0.600	0.012	0.024
θ	0°	8°	0°	8°

MSOP-8

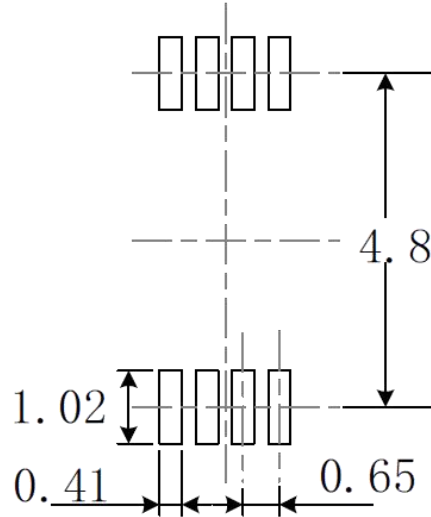
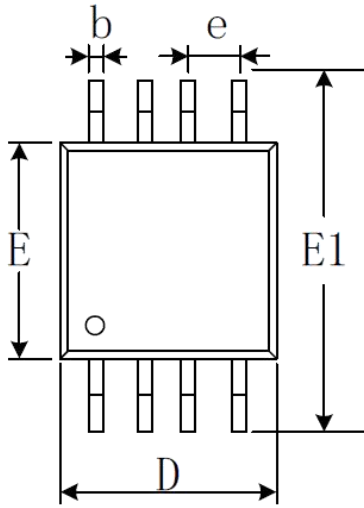

RECOMMENDED LAND PATTERN (Unit: mm)

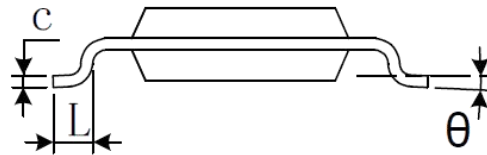
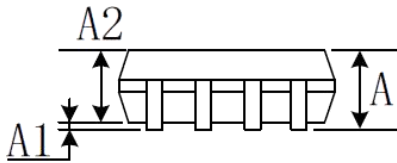

Symbol	Dimensions In Millimeters		Dimensions Inches	
	Min	Max	Min	Max
A	0.820	1.100	0.032	0.043
A1	0.020	0.150	0.001	0.006
A2	0.750	0.950	0.030	0.037
b	0.250	0.380	0.010	0.015
c	0.090	0.230	0.004	0.009
D	2.900	3.100	0.114	0.122
E	2.900	3.100	0.114	0.122
E1	4.750	5.050	0.187	0.199
e	0.650 BSC		0.026 BSC	
L	0.400	0.800	0.016	0.031
θ	0°	6°	0°	6°

TSSOP-14

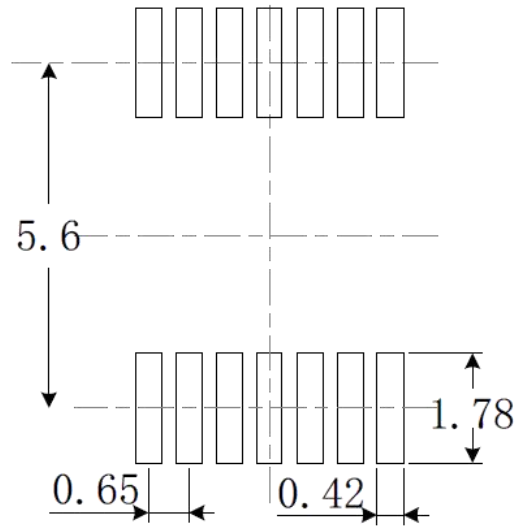
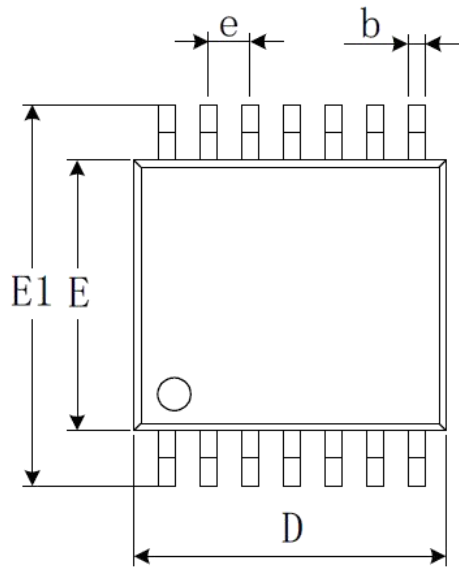

RECOMMENDED LAND PATTERN (Unit: mm)

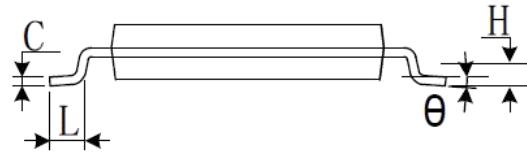
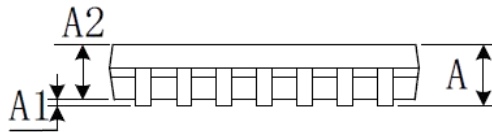

Symbol	Dimensions In Millimeters		Dimensions Inches	
	Min	Max	Min	Max
A		1.200		0.047
A1	0.050	0.150	0.002	0.006
A2	0.800	1.050	0.031	0.041
b	0.190	0.300	0.007	0.012
c	0.090	0.200	0.004	0.008
D	4.860	5.100	0.191	0.201
E	4.300	4.500	0.169	0.177
E1	6.250	6.550	0.246	0.258
e	0.650 BSC		0.026 BSC	
L	0.500	0.700	0.020	0.028
H	0.25 TYP		0.01 TYP	
θ	1°	7°	1°	7°

SOIC-8(SOP8)

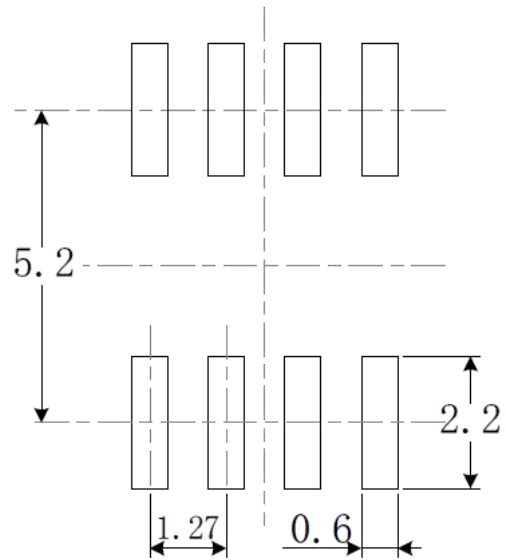
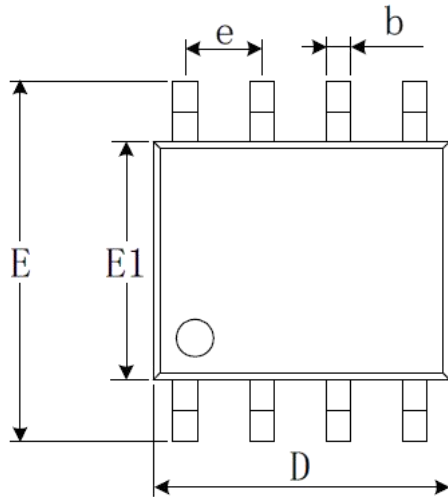

RECOMMENDED LAND PATTERN (Unit: mm)

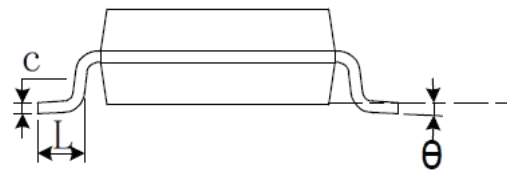
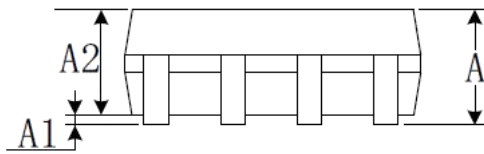

Symbol	Dimensions In Millimeters		Dimensions Inches	
	Min	Max	Min	Max
A	1.350	1.750	0.053	0.069
A1	0.100	0.250	0.004	0.010
A2	1.350	1.550	0.053	0.061
b	0.330	0.510	0.013	0.020
c	0.170	0.250	0.007	0.010
D	4.800	5.000	0.189	0.197
E	5.800	6.200	0.228	0.244
E1	3.800	4.000	0.150	0.157
e	1.270 BSC		0.050 BSC	
L	0.400	1.270	0.016	0.050
θ	0°	8°	0°	8°

SOIC-14(SOP14)

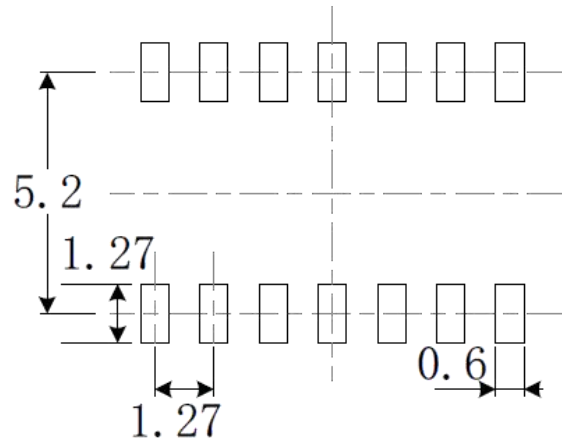
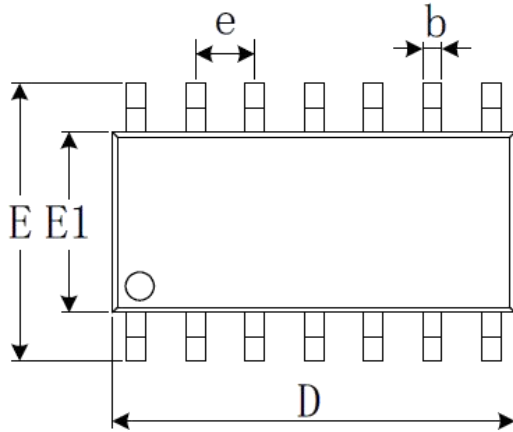

RECOMMENDED LAND PATTERN (Unit: mm)

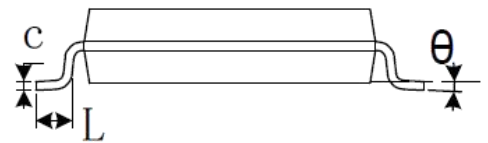
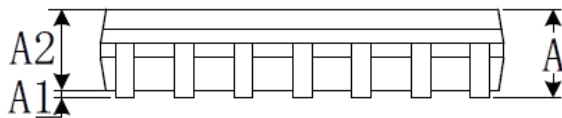

Symbol	Dimensions In Millimeters		Dimensions Inches	
	Min	Max	Min	Max
A	1.350	1.750	0.053	0.069
A1	0.100	0.250	0.004	0.010
A2	1.350	1.550	0.053	0.061
b	0.0310	0.510	0.012	0.020
c	0.100	0.250	0.004	0.010
D	8.450	8.850	0.333	0.348
E	5.800	6.200	0.228	0.244
E1	3.800	4.000	0.150	0.157
e	1.270 BSC		0.050 BSC	
L	0.400	1.270	0.016	0.050
θ	0°	8°	0°	8°

PACKAGE/ORDERING INFORMATION

PRODUCT	ORDERING	TEMPRANGE	PACKAGE	PAKEAGE	TRANSPOT
CBM8031	CBM8031AS8	-40°C~125°C	SOIC-8(SOP8)	CBM8031	Tape and Reel,2500
	CBM8031ATS5	-40°C~125°C	SOT23-5	8031	Tape and Reel,3000
	CBM8031ABS5	-40°C~125°C	SOT23-5	8031B	Tape and Reel,3000
	CBM8031AMS8	-40°C~125°C	MSOP-8	CBM8031	Tape and Reel,3000
CBM8032	CBM8032AS8	-40°C~125°C	SOIC-8(SOP8)	CBM8032	Tape and Reel,2500
	CBM8032AMS8	-40°C~125°C	MSOP-8	CBM8032	Tape and Reel,3000
CBM8034	CBM8034AS14	-40°C~125°C	SOIC-14(SOP14)	CBM8034	Tape and Reel,2500
	CBM8034ATS14	-40°C~125°C	TSSOP-14	CBM8034	Tape and Reel,3000